

Downlight Specification

G2SR50S2(E)

— GENIE 2S series



Basic Parameters

- Material: ADC12, spraying surface
- Driver Installation: Remote
- IP grade: IP20/IP54 optional
- CCT: 2700/3000/3500/4000K/2700-6500K optional
- CRI: 90
- SDCM(Light source): <3 Step (ANSI)
- Beam angle: 15°/24°/28°/36°/45° optional
- UGR(X=4H,Y=8H): ≤13(15°/24°/28°/36°), ≤19(45°)
- Lighting direction: Downward
- Dimming method: Non / 0-10V / Traic / DALI optional
- Input voltage: AC220-240V
- Working temperature: -15°C~30°C
- Application: Indoor
- Installation: Trimless Recessed
- Certification: CE, ROHS, Reach
- Warranty: 5 years



Frame Color



Black



White

Reflector type

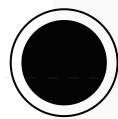

Matte black



Matte white



Mirror



Black chrome

Optical Accessory



Honeycomb



Linear Spread Filter



Diffusion Filter

Product mechanical data

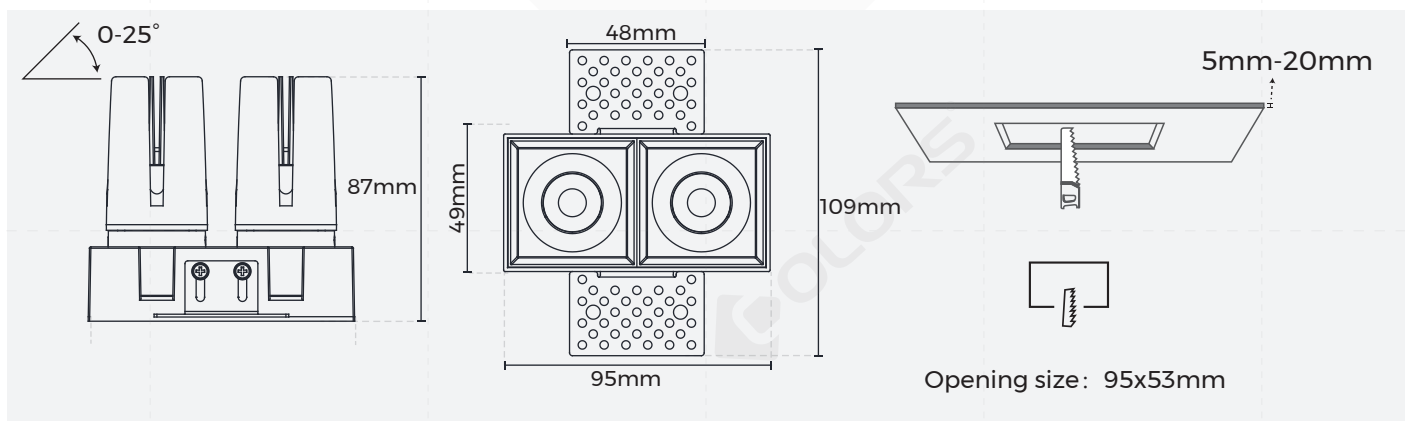

◎Luminaire Parameters

Note: Specifications listed herein apply exclusively to the single-head configuration. For dual-head spotlight modules, all corresponding parameters shall be doubled (2× baseline values).

Version	Input Voltage (V)	Input Current .LED(mA)	Type Power (W)	CRI	Beam Angle	CCT	Lumen (LM)
Normal	DC36	150	6	>90	15°	3000K	240
					24°	3000K	335
					36°	3000K	340
					45°	3000K	340
Normal	DC36	200	9	>90	24°	3000K	460
					36°	3000K	470
					45°	3000K	470
CCT Tunable	DC36	150	6	>90	28°	4000K	330
					36°	4000K	330
CCT Tunable	DC36	200	9	>90	28°	4000K	450
					36°	4000K	450

Note:

1. The above parameters are tested based on the light source with Color Rendering Index Ra90 and 3000K for the Normal version;

Luminous efficiency & luminous flux at 2700K = 3000K value × 0.95

Luminous efficiency & luminous flux at 3500K = 3000K value × 1.05

Luminous efficiency & luminous flux at 4000K = 3000K value × 1.08

2. For CCT Tunable version:

The above parameters are tested based on the light source with Color Rendering Index Ra90 and 4000K;

Luminous efficiency & luminous flux at 2700K = 4000K value × 0.9

Luminous efficiency & luminous flux at 6500K = 4000K value × 0.95

3. If the "Honeycomb" is selected, it will be installed on the spotlight by default, and the parameters will change as follows.

(1)Spotlights with beam angles of "15°", "24°" and "28°":the light efficiency will be reduced by 30%, the beam Angle will be reduced by 12%, the anti-glare effect will be better, and the UGR will be reduced by 40%.

(2)Spotlights with beam angles of "36°" and "45°":the light efficiency will be reduced by 50%, the beam Angle will be reduced by 25%, the anti-glare effect will be better, and the UGR will be reduced by 40%.

4. The luminous flux allows an error range of ±10%.

5. The above parameters are typical values.

6. The power supply brands used are Eagor, Lifud, or Adiming.

◎Optical Parameter

Note: Specifications listed herein apply exclusively to the single-head configuration. For dual-head spotlight modules, all corresponding parameters shall be doubled (2× baseline values).

- Normal

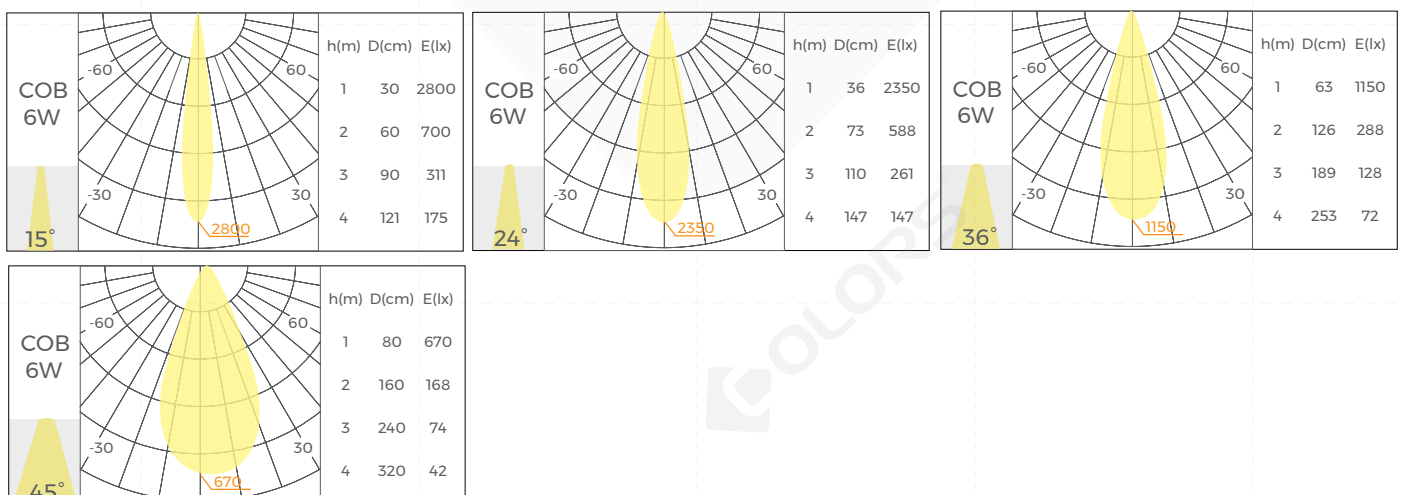

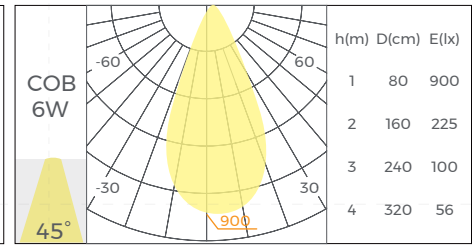
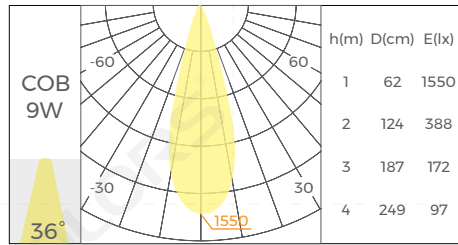
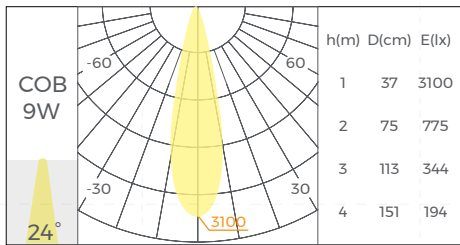

- CCT Tunable

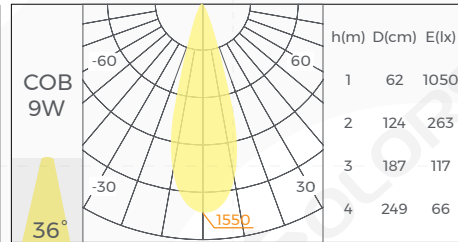
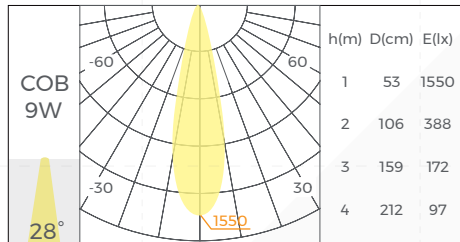
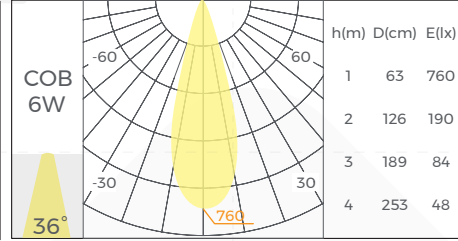
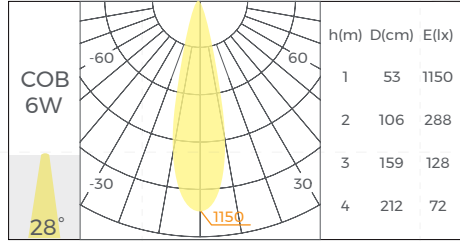

Note:

1. Central light intensity value = 1 meter maximum luminous intensity value;
1. N meter maximum luminous intensity value = Central light intensity value/N²;
For example: 2 meter maximum luminous intensity value = Central light intensity value/2²;

⊙Packing

Model	Size (mm/box)	Quantity /box	Quantity /carton	NW (kg/box)	NW (kg/carton)	CW (kg)	Size (mm/carton)
Non-Dimming/No Power model	120*120*95	1	48	0.36	17.28	20.6	496*496*306
Dimming model	156*145*95	1	48	0.36	17.28	21.6	599*485*402

⊙Model Code

DL - G2S	R	50	S	2	(ETW) - 09	90	30	36 -	N	B	B		
System DL Downlights	Series G2S: GENIE ZS	Installation E. Recessed R. Trimless Recessed	Opening Size 95x53mm	Diffuser S: Square	Type 1: 1-head 2: 2-heads	Version EN: Normal version ETW: CCT Tunable	Type Power 09: 9W	CRI 90: Ra>90	CCT 27: 2700K 30: 3000K 35: 3500K 40: 4000K 26: 2600-6500K	Beam angle 36: 36°	Dimming Method N: Non-Dimming D: 0-10V Dimming A: DALI Dimming T: Triac Dimming X: No Power	Color W: White(Frame) B: Black(Frame)	Reflector Color M: Mirror C: Black chrome B: Matte Black M: Matte White

⊙Attentions

1. Non-professionals are prohibited from installing, disassembling and repairing the product.
2. Avoid scratching, distortion and irregular bending of the product during installation; otherwise it may cause irreparable damage to the product.
3. Please use professional cutting tools when cutting
4. Do not use any acid or alkaline adhesive to fix products
5. The product is only suitable for indoor dry places, can not be used in outdoor, seaside or wet environment.